



AVS-Monitor 10" BV

integriertes/integrated Bird View System 2D/3D



Produktvarianten / Product variants

3030018 AVS-Monitor 10" BV ▪ Bird View 2D/3D

Key Facts

- | | |
|--|--|
| <ul style="list-style-type: none">▪ Bilddiagonale 10.1" - Touchscreen▪ Auflösung 1024x600▪ Hintergrundbeleuchtung 600cd/m²▪ Betriebstemperaturbereich von -20°C bis +70°C▪ Lagertemperaturbereich -30°C bis +80°C▪ mechanische Belastbarkeit bis zu 7 g▪ Kontrastverhältnis 600:1▪ Spannungsversorgung 10-32V DC▪ Stromverbrauch max. 30W▪ Betrachtungswinkel
oben 85°, unten 85°, rechts/links 85°▪ Trigger frei wählbar▪ Touchdisplay verriegelbar▪ Anschlusskabel 2 Meter▪ Schutzklasse IP30▪ Gewicht 0,94kg▪ Bird View Steuereinheit integriert
2D / 3D Ansicht
Personenerkennung in Verbindung mit
AVS-Camera 170° AI möglich | <ul style="list-style-type: none">▪ LCD Size 10.1" - Touchscreen▪ Resolution 1024x600▪ Brightness 600cd/m²▪ Operating temperature von -20°C to +70°C▪ Storage temperature von -30°C to +80°C▪ Vibration up to 7 g▪ Contrast 600:1▪ Power supply 10-32V DC▪ Power consumption max. 30W▪ Viewing angle
up 85°, down 85°, right/left 85°▪ Trigger freely selectable▪ Touchdisplay lockable▪ Cable 2 Meter▪ Protection class IP30▪ Weight 0,94kg▪ Bird View Control Unit integrated
2D / 3D view
Person recognition possible in connection with
AVS-Camera 170° AI |
|--|--|

Lieferumfang / Scope of Delivery

- | | |
|--|--|
| <ul style="list-style-type: none">▪ Monitor 10"▪ U-Bügelhalterung + Schrauben▪ Lichtschutzhaube▪ Basis Halterung▪ Anschlusskabel▪ Anleitung▪ Fernbedienung | <ul style="list-style-type: none">▪ Monitor 10"▪ U-Mount + Screws▪ Light protection shield▪ Base Mount▪ Connection cable▪ Instructions▪ Remote Control |
|--|--|

Systemskizze / System drawing

AVS-Monitor 10" BV



10...32V DC

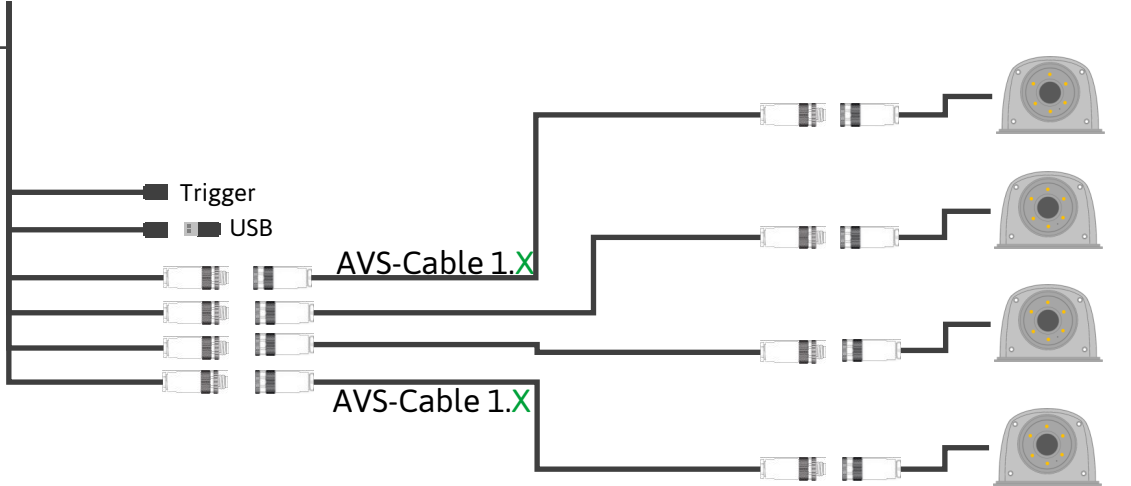

Maße / Dimensions

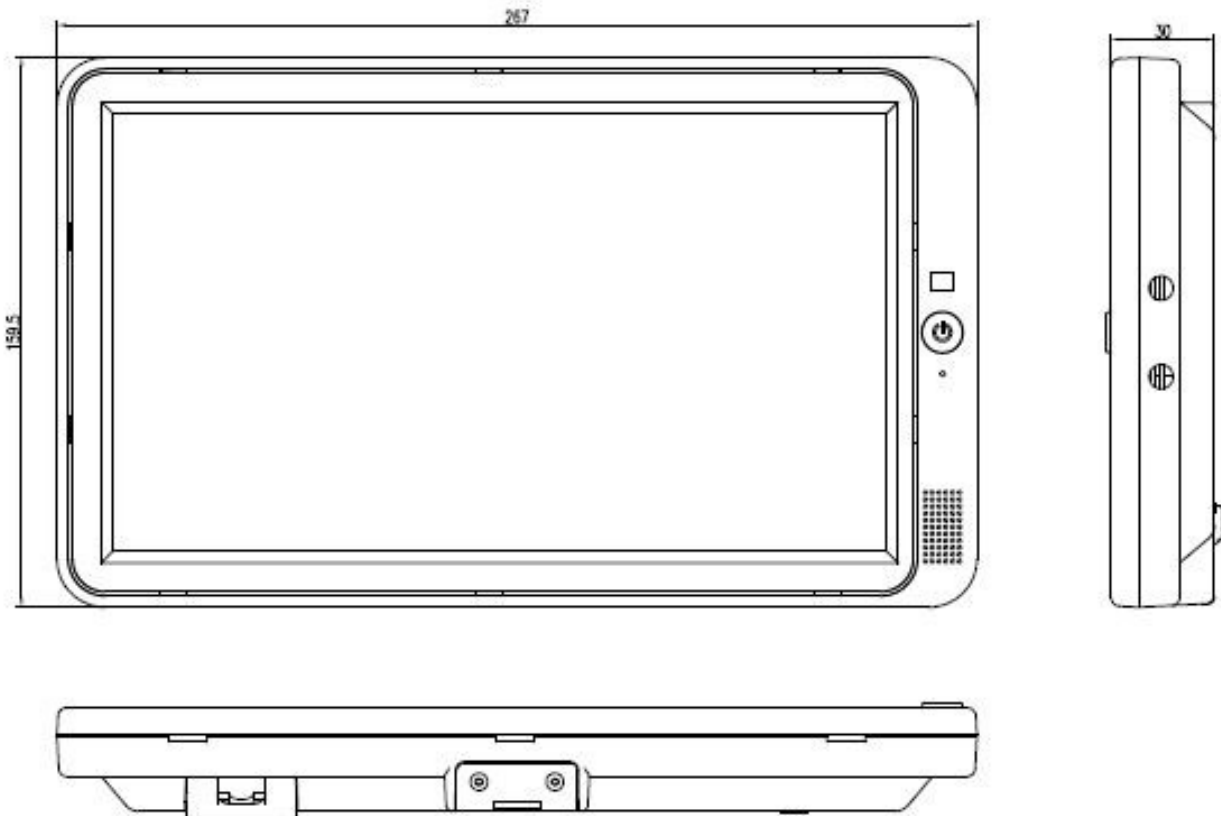

Maße in / Dimensions in mm

Kabel / Cable

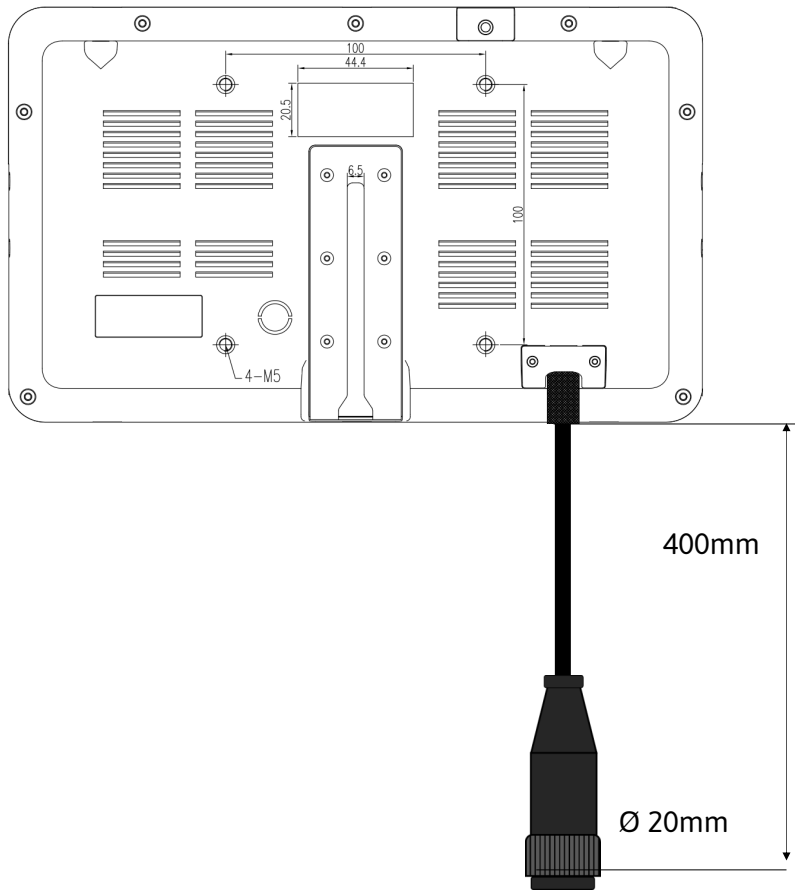

- VDC
- GND
- Trigger 1
- Trigger 2
- Trigger 3
- Trigger 4
- Trigger 5

Trigger sind frei konfigurierbar
Trigger are freely configurable

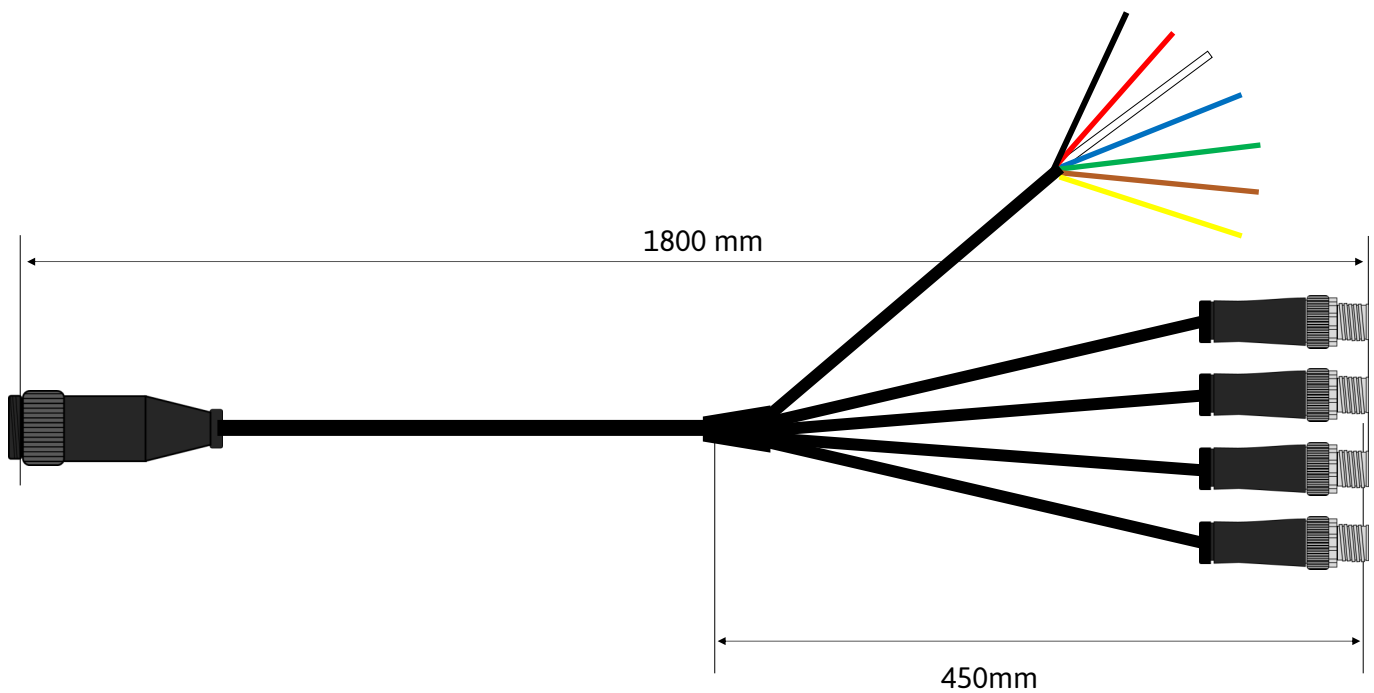

GX-12 aviation 4p - Stecker, IP67
GX-12 aviation 4p - Male, IP67

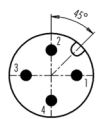

Kamera / Camera Bird View Standard

3010005

AVS-Camera 190° FHD

▪ Bildwinkel 190°

▪ *Viewing angle 190°*

Technische Daten / Technical specifications

- | | |
|---|---|
| <ul style="list-style-type: none">▪ Auflösung 1920x1080▪ Bildsensor CMOS 1/2.9"▪ Gegenlichtkompensation Automatisch▪ Spannungsversorgung 12V DC▪ Stromverbrauch ca. 220mA▪ Bildwinkel 105°, 145° & 190° erhältlich▪ Beleuchtung 0.1 Lux (Tag), 0 Lux (mit IR 3-5Meter)▪ Schutzklasse IP69K▪ FPS 25/30▪ Betriebstemperaturbereich -20°C bis +70°C▪ Lagertemperaturbereich -40°C bis +85°C▪ Vibration 10g▪ Anschlusskabel 0,8 Meter▪ Gewicht mit Montageplatte 0,27kg▪ Gewicht ohne Montageplatte 0,17kg | <ul style="list-style-type: none">▪ Resolution 1920x1080▪ Image Sensor CMOS 1/2.9"▪ Backlight compensation Automatic▪ Power supply 12V DC▪ Power consumption ca. 220mA▪ Viewing angel 105°, 145° & 190° available▪ Lightning 0.1 Lux (Day), 0 Lux (with IR 3-5Meter)▪ Protection class IP69K▪ FPS 25/30▪ Operating temperature -20°C to +70°C▪ Storage temperature -40°C to +85°C▪ Vibration 10g▪ Cable 0,8 Meter▪ Weight with Mounting plate 0,27kg▪ Weight without Mounting plate 0,17kg |
|---|---|

Stecker / Connector

GX-12 aviation 4p - Buchse, IP67

GX-12 aviation 4p - Stecker, IP67

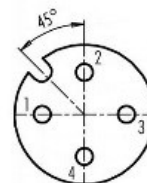

Maße / Dimensions

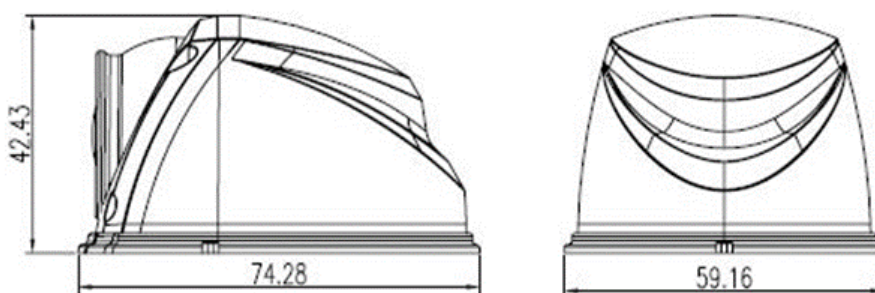

Maße in / Dimensions in mm

Produktvarianten / Product variants

3010184

AVS-Camera-170° AI

▪ Bildwinkel 170°

▪ Viewing angle 170°

Key Facts

- | | |
|---|--|
| <ul style="list-style-type: none"> ▪ Auflösung 1920x1080 ▪ Bildsensor CMOS 1/2.9" ▪ Gegenlichtkompensation Automatisch ▪ Spannungsversorgung 10-32V DC ▪ Stromverbrauch ca. 320mA ▪ Bildwinkel 170° ▪ Schutzklasse IP69K ▪ FPS 25/30 ▪ Betriebstemperaturbereich -20°C bis +70°C ▪ Lagertemperaturbereich -40°C bis +85°C ▪ Vibration 5,9g ▪ Anschlusskabel 0,3 Meter (Adapter 1m) ▪ Gewicht 0,47kg | <ul style="list-style-type: none"> ▪ Resolution 1920x1080 ▪ Image Sensor CMOS 1/2.9" ▪ Backlight compensation Automatic ▪ Power supply 10-32V DC ▪ Power consumption ca. 320mA ▪ Viewing angel 170° ▪ Protection class IP69K ▪ FPS 25/30 ▪ Operating temperature -20°C to +70°C ▪ Storage temperature -40°C to +85°C ▪ Vibration 5,9g ▪ Cable 0,3 Meter (Adapter 1m) ▪ Weight 0,47kg |
|---|--|

Stecker / Connector

Kamerakabel Buchse 8p
Camera Cable Female 8p

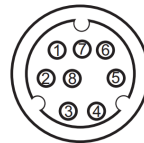

Adapter inkl.:

Stecker 8p auf GX-12 aviation 4p Buchse + 1x Alarm Out
Male 8p to GX-12 aviation 4p-Female + 1x Alarm Out

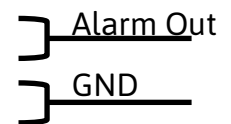
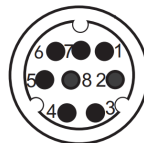

Maße / Dimensions

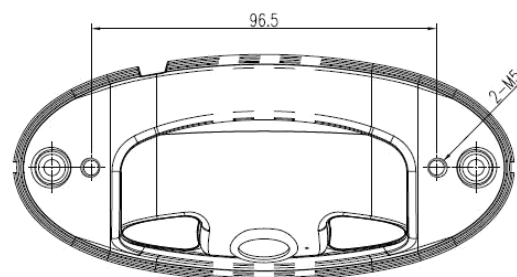
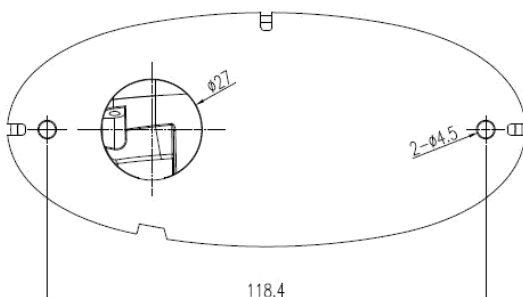
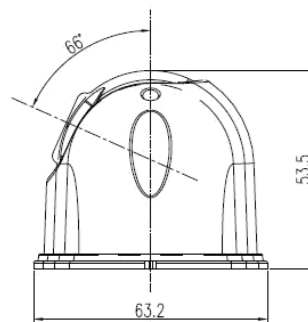
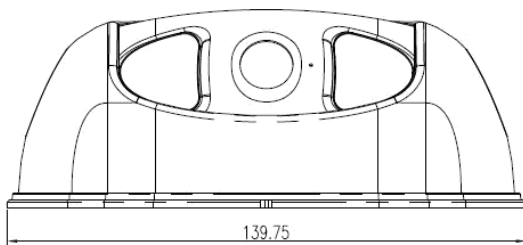

Maße in / Dimensions in mm

